

Optional P/N 2282 3/8" holder and P/N 2295 carbide insert holder.

**SHERLINE**  
**PRODUCTS**  
INCORPORATED 1974

## QUICK-CHANGE TOOLPOST AND TOOL HOLDERS

P/N 2250 (And optional P/N 2295)

### Purpose of the the quick-change toolpost

In a modern production machine shop, time is money, so being able to change tools quickly on a lathe becomes an economic necessity. Years ago a dovetailed holder and cam locking arrangement was developed to make it possible to quickly change tools while leaving the body of the toolholder mounted to the table. For most users of tabletop size machine tools, however, the economic factor is not the prime reason for going to a quick-change tool system. Being able to change tools quickly simply means more time is spent doing the productive part of the job, and less time is wasted changing tools. The Sherline P/N 2250 quick-change set includes the toolpost and three holders: the P/N 2280 1/4" tool bit holder, the P/N 2285 3/8" boring tool holder and the P/N 2285 cutoff tool holder. An optional holder for inserted tip carbide tools is available as P/N 2295.

### Construction of the quick-change toolpost and holders

The toolpost body and holders are machined from steel, case hardened and coated with a black oxide finish. This provides a very durable product that should provide generations of service if cared for. Two dovetails are provided on the toolpost so holders can be mounted in a choice of positions. The individual holders are locked in place with a cam against a dovetailed slide that is tightened using the same hex key used for many other Sherline operations.

### Mounting the toolpost and changing holders

The toolpost is mounted to the lathe table using the same T-nut arrangement as the standard Sherline toolpost. A secondary clamp is also provided and may be used to insure the toolpost doesn't move. The horizontal flange of the angle clamp goes in the groove around the base of the toolpost. The tool holder is then slipped over the appropriate dovetail on the toolpost. The height of the tool tip is adjusted using the knurled handwheel. The cutting tip of the tool should be set to the centerline of the lathe by bringing the tool tip up to a Morse dead center in either the headstock or tailstock spindle. Once the height is set,

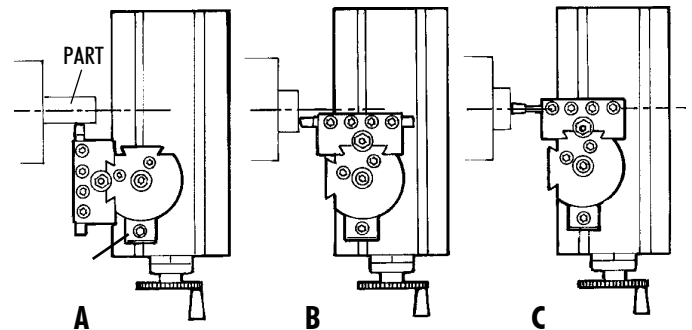

FIGURE 1—The 1/4" cutting tool can be mounted in either position. Figure A shows the position for cutting and Figure B shows the position for facing. Figure C shows the boring tool positioned to bore the end of a piece of stock.

lock the knurled wheel in position with the hex nut. The holder can now be removed and replaced and the tool will remain at the proper height.

### The boring tool holder

The boring tool holder will accept any boring tool with a 3/8" shank. This includes the 3/8" boring tools (P/N 3061 and 3063) used with the P/N 3054 Sherline boring head. A variety of boring tool sets are available that would also fit the holder. These can be obtained from independent tool supply companies. It is a good idea to grind a small flat for the clamping screw to locate on. It isn't necessary to clamp all four screws to hold the tool. One or two will be sufficient. The additional screws are there to clamp a tool when the holder is used on the other dovetail.

### Using a parting tool

After completing a part in the lathe it is frequently necessary to separate the part from the excess material used for chucking. This operation is best accomplished with the use of a cut-off tool or "parting tool" as it is sometimes called. The Sherline cut-off tool holder utilizes a very slender high speed tool steel cutting blade. The thinness of the Sherline blade (.040") enables it to feed into the part quite easily and

SHERLINE PRODUCTS INC. • 3235 Executive Ridge • Vista • California 92081-8527

FAX: (760) 727-7857 • Toll Free Order Line: (800) 541-0735 • International/Local/Tech. Assistance: (760) 727-5857 • Internet: www.sherline.com

**FIGURE 2**—The cutoff tool or “parting” tool is held as shown. The height of the cutting tip of the blade should be adjusted using the height adjustment wheel until it is exactly on center with the spindle.

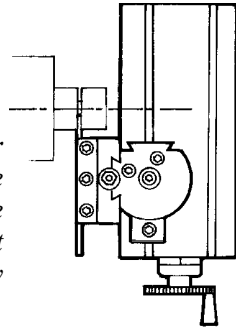

at the same time minimizes the amount of waste material. If you use a non-Sherline blade, it is recommended that the blade be no wider than 1/16" when used in this holder. The turning speed for parting should be approximately one-half the normal turning speed for any given material. One word of caution; never use a parting tool on a part mounted between centers. The part may bind on the cutter and result in a scrapped part or a broken cutting tool.

Always try to lay work out so the cut-off tool is used as close to the spindle as possible. Set blade height using the adjustment wheel on the toolholder. It should be set so the tip is aligned with the centerline of the part being cut.

**NOTE: ALWAYS USE CUTTING OIL WHEN USING THE CUT-OFF TOOL.** The cut will be made much smoother, easier and cooler.

Speed should be slower than normal turning speed and feed rate should be a little heavy so the chip will not break up in the slot. If speed and feed are correct, there will not be any chatter, and the chip will come out as if it were being unrolled from a spool. Coolant (cutting oil) plays a major roll in this occurring properly.

If the tool chatters, first check to see if the work is being held properly. Then decrease speed (RPM) or increase feed rate or both. Once the blade has chattered, it leaves a serrated finish which causes more chatter. Sometimes a serrated finish can be eliminated by turning the spindle off, adding a liberal amount of cutting oil, bringing the blade up so there is a slight pressure on it without the spindle turning, and then turning by hand or as slowly as possible with the speed control to remove the chatter marks.

**Sharpening Instructions**

To sharpen the blade, set the tool support on the grinder in such a way that it will produce a 7° to 10° angle on the blade (top to bottom). (See Figure 3.)

**FIGURE 3**—Side view of blade.



**FIGURE 4**—Top view of blade (enlarged) when ground for “parting off”.

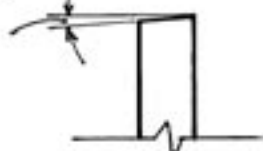

If you are sharpening the blade to “part off”, the blade should have an additional angle of approximately 5° when viewed from the top with the point on the right. (See Figure 4.) Normally the angle would be as high as 15° but the .040" thickness of the blade would not be rigid enough and the blade could bend. If you want to cut grooves, don't put any angle on the blade when seen from the top.

If the cutting edges on the sides get dull, grind off the end of the blade until you get into new material where the edges are sharp to the cutting end. New blades are available as P/N 3086 from Sherline Products for \$15.00.

**Care of your toolpost and holders**

The case hardened and black oxide-finished steel components are very tough, but the corners and dovetail edges can be chipped if dropped or banged together. They should be protected from each other in your tool drawer. Because they are steel, they should also be protected with a light coating of rust preventative before putting them away.

**Cutting tools available**

Cutting tools are available from Sherline for the holders as follows:

- 1/4" cutting tool blank (P/N 3005) or a package of five blank 1/4" tools (P/N 3005B)
- 1/4" brazed tip carbide cutting tool set of 3 tools: left, right and 60° threading (P/N 3006)
- 1/4" pre-sharpened HSS cutting tool set of 3 tools: left, right and boring tool (P/N 3007)
- Cutoff tool blade ( P/N 3086)
- 3/8" diameter boring tool holder that takes 55° inserted carbide tips (P/N 7635) or 3/8" diameter boring tool holder that takes 80° carbide inserts (P/N 7638)

—Joe Martin, President and Owner  
SHERLINE Products

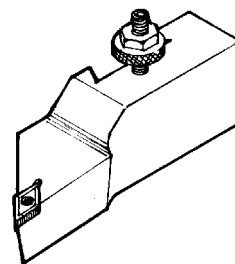

**Using the optional P/N 2295 inserted tip carbide cutting tool holder**

For those who wish to take advantage of the superior cutting ability of carbide cutting tools, Sherline offers a tool holder for 55° inserted carbide tips. The P/N 2295 holder comes with one carbide insert which has 2 cutting edges. It is held in place with a small screw. A special Torx wrench to tighten the screw is also included. Like the P/N 2250 toolpost and three dovetailed holders, the inserted tip holder is manufactured from steel, case hardened and given a black oxide finish.

FIGURE 5—The inserted tip holder can be used for cutting as shown or for facing as shown in figure 1B on the first page.

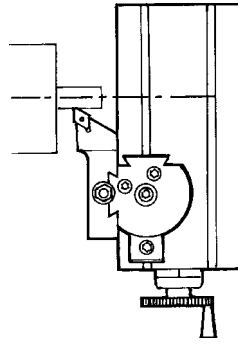

**Replacement carbide inserts**

Replacement inserts for this holder are available from Sherline as well as from several other tool manufacturers. Sherline's replacement number for a single carbide tip is P/N 7605. They are also available in a box of ten as P/N 7605B.

**Riser block available**

When using the quick-change tool post with the riser blocks in place on the lathe, a 1.25" riser block is now available. Ask for P/N 2251.

**Optional P/N 2282 Holder for 3/8" shank tools**

Due to many customer requests, in 2008 another optional holder was added. It is made from larger 1-3/16" stock to handle the additional stress of holding a 3/8" shank tool. This means you can now use inserted tip tool holders like the P/N 2256 and 2257 plus other similar tools with your quick-change tool holder.

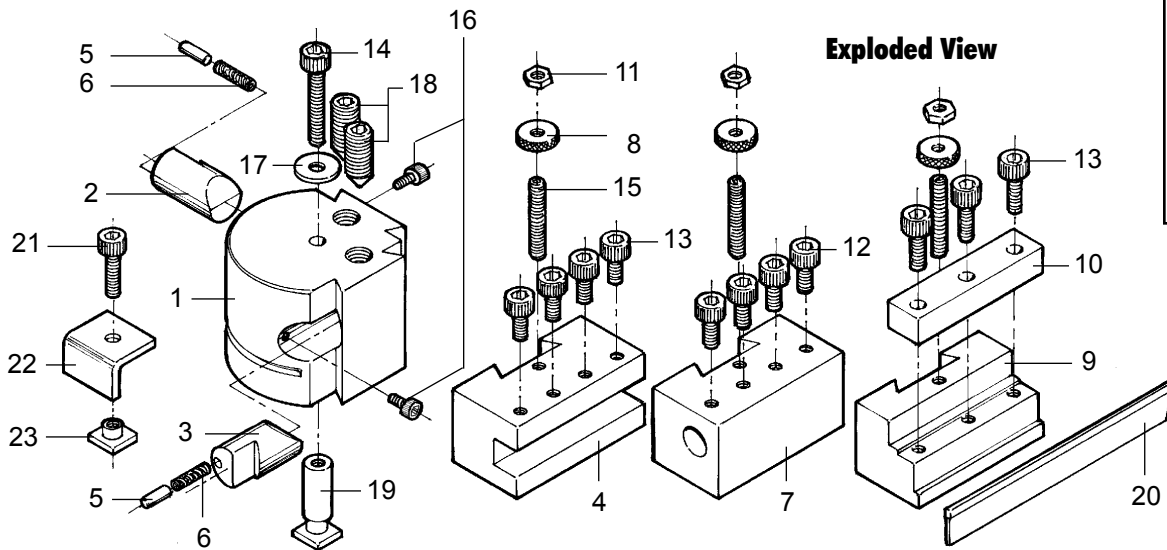

**Optional Tool Holders**

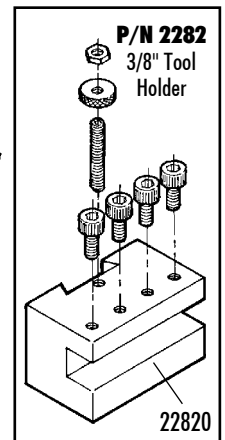
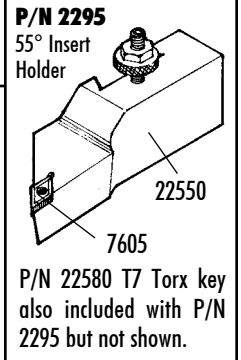

**Quick-Change Tool Post Parts List**

REF NO.	NO. REQ.	PART NO.	DESCRIPTION	REF NO.	NO. REQ.	PART NO.	DESCRIPTION
1	1	22510	Toolpost body	13	7	40670	10-32 x 1/2" SHCS
2	1	22520	Left hand cam	14	1	40340	10-32 x 1" SHCS
3	1	22530	Right hand cam	15	3	22560	10-32 x 1" cone point set screw
4	1	22600	1/4" tool bit holder	16	2	22570	4-40 x 1/4" SHCS
5	2	22620	Cam spring pin	17	1	40660	3/16" I.D. washer
6	2	22630	.120" x 7/16" springs	18	2	40540	5/16" x 3/4" cone point set screw
7	1	22650	3/8" boring tool holder	19	1	40250	Extended toolpost T-nut
8	3	22680	Knurled height adjustment nut	20	1	30860	Cutoff tool blade (sold separately)
9	1	22700	Cutoff tool holder body	21	1	40330	10-32 x 5/8" SHCS
10	1	22710	Cutoff tool holder clamp	22	1	35580	Hold-down clamp
11	3	32100	10-32 hex nut	23	1	30560	10-32 T-nut
12	4	40510	10-32 x 3/8" SHCS				